

*jura*<sup>®</sup>



**X4** (EB/SB/INTB)  
Instructions for Use



Original instructions for use  
Before using the machine read the instructions for use.

JURA Type 775

# Your X4

<b>1 Control elements</b>	4
<b>2 For your safety</b>	6
Comply with the instructions for use	6
Proper use	6
User limitations	6
Use by children	7
What to do in the event of damage	7
Preventing damage	8
Danger of electric shock	9
Danger of burns, scalding and injury	9
<b>3 Preparing and using for the first time</b>	10
Setting up the machine	10
Filling the bean container	10
Determining the water hardness	10
First-time use	11
Managing your X4 – the JURA Cockpit	12
<b>4 Preparation</b>	12
Espresso and coffee	13
Americano and lungo	13
Espresso doppio	13
Hot water	13
Adjusting the grinder	14
Adjusting the product settings	14
<b>5 Daily operation</b>	15
Switching the machine on and off	15
Filling the water tank	15
Maintenance actions	16
<b>6 Machine settings</b>	17
<b>7 Maintenance</b>	18
Rinsing the machine	18
Inserting/changing the filter	18
Cleaning the machine	19
Descaling the machine	20
Descaling the water tank	21
Cleaning the bean container	21

<b>8</b>	<b>Display messages</b> .....	22
<b>9</b>	<b>Troubleshooting</b> .....	23
<b>10</b>	<b>Transport and environmentally friendly disposal</b> .....	24
	Transport / Emptying the system .....	24
	Disposal .....	24
<b>11</b>	<b>Technical data</b> .....	25
<b>12</b>	<b>Index</b> .....	26
<b>13</b>	<b>JURA contact details / Legal information</b> .....	28

# 1 Control elements

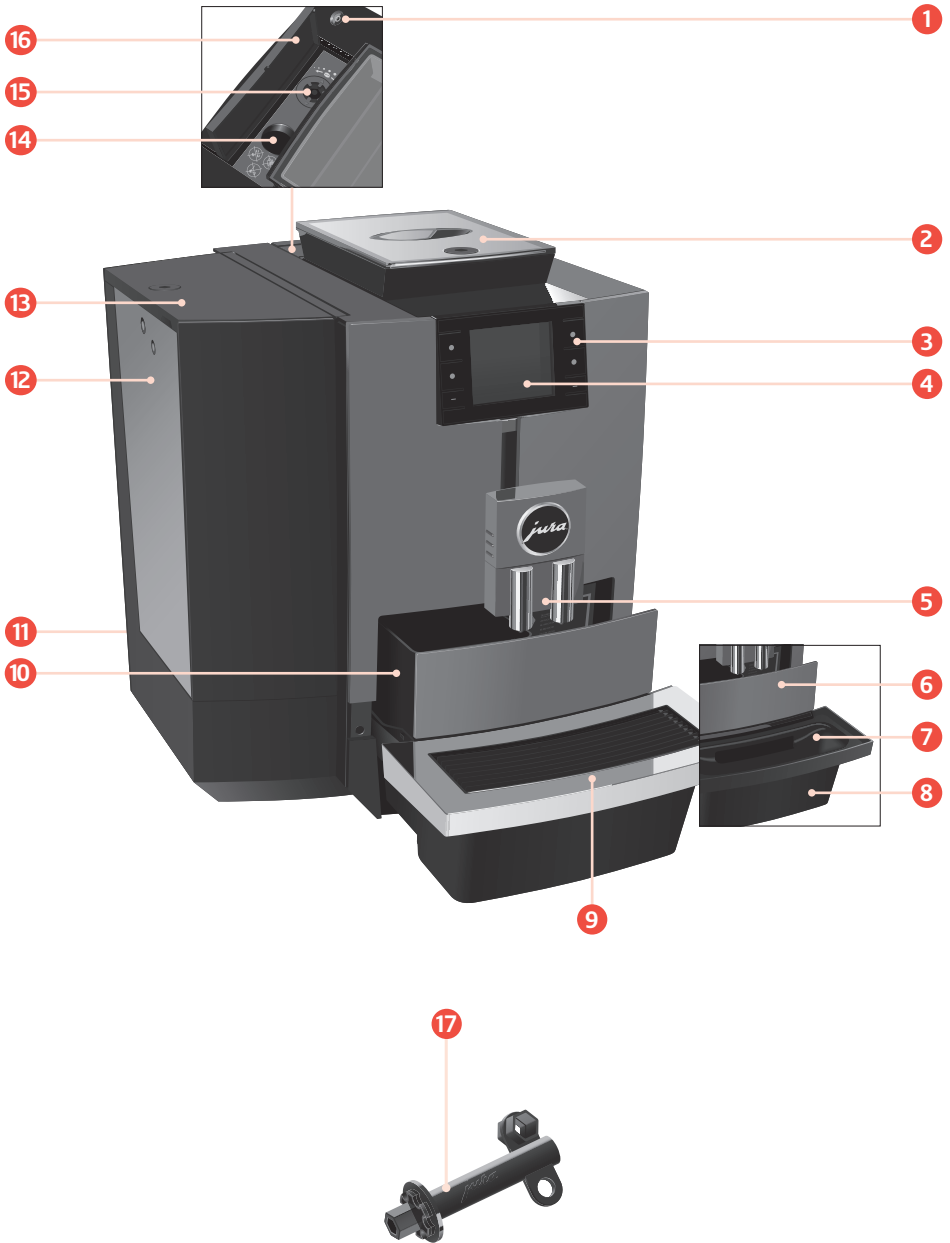

- 1 On/Off button 
- 2 Bean container with aroma preservation cover (lockable)
- 3 Multi-function buttons (button function depends on what is shown in the display)
- 4 Display
- 5 Height-adjustable coffee spout (with hot-water spout)
- 6 Insert with panel
- 7 Insert for drip tray
- 8 Drip tray
- 9 Cup grille
- 10 Coffee grounds container
- 11 Mains cable (back of the machine)
- 12 Water tank
- 13 Water tank cover (lockable)
- 14 Filler funnel for cleaning tablet
- 15 Grinder adjustment wheel
- 16 Cover
- 17 Spanner for aroma preservation cover, water tank cover and grinder adjustment wheel

Service socket for optional JURA Connector





## 2 For your safety

### Comply with the instructions for use

Before using the machine, read these instructions for use thoroughly and completely and comply with the instructions they contain. Keep these instructions for use close to the machine and pass them on to the next user.

Failure to observe the instructions for use may result in serious injuries or damage to property. Safety information is therefore indicated as follows:

 <b>WARNING</b>	Indicates circumstances that may result in serious injuries or death.
 <b>CAUTION</b>	Indicates circumstances that may result in minor injuries.
<b>CAUTION</b>	Indicates circumstances that may result in damage to property.

### Proper use

This machine is intended for use by specialist or trained staff in businesses, light industry and agricultural facilities or for commercial use by non-professionals. It should only be used for coffee preparation and to heat water. Use for any other purpose will be deemed improper.

### User limitations

People, including children, who

- do not have the physical, sensory or mental capabilities to use the machine safely or
- are inexperienced or lack knowledge

must be supervised by a responsible person when using it, or must be instructed in how to use it correctly.

When using the CLARIS Pro Smart+ / Pro Smart maxi filter cartridge or a JURA Connector, wireless connections are established. Specific details on the frequency band used and the maximum transmission power can be found in the 'Technical data' section.

## Use by children

**Children must be able to recognise and understand the potential dangers arising from incorrect use:**

- Keep **children under the age of 8** away from the machine, or supervise them constantly.
- **Children aged 8 and over** may only operate the machine without supervision if they have been instructed in how to use it safely.
- Children may not clean or service the machine unless supervised by a responsible person.
- Do not allow children to play with the machine.

## What to do in the event of damage

**Never use a damaged machine or mains cable. This could result in fatal electric shock.**

- In the event of signs of damage, disconnect the machine from the mains. To do this, first switch the X4 off with the On/Off button . Only then should you remove the mains plug from the power socket.
- Only permit authorised JURA service centres to carry out **repairs to the machine** and the **permanently connected mains cable**. Unsuitable repairs may result in consequential damage.

## Preventing damage

### To avoid damage to the machine and the mains cable:

- The X4 must not be placed in a cabinet when in use.
- Do not use the X4 and the mains cable near hot surfaces.
- Do not allow the mains cable to rub against sharp edges and ensure that it does not become trapped.
- Never allow the mains cable to loosely hang down. The mains cable could pose a tripping hazard or become damaged.
- Protect the X4 from weather and direct sunlight.
- Only connect the X4 to a mains voltage corresponding to that stated on the rating plate. The rating plate is located on the underside.
- Connect the X4 directly to a domestic power socket. Using multi-socket adapters or extension cords may cause overheating.
- The surface of the heating element and outer enclosure remains hot after use and the outside of the appliance may retain heat.
- Do not use alkaline or alcohol-based cleaning agents; only use mild cleaning agents and a soft cloth.
- Do not use any coffee beans treated with additives or caramelised coffee beans.
- Only fill the water tank with fresh, cold, non-carbonated water.
- Switch the machine off with the On/Off button  if you are going to be absent for a longer period of time and remove the mains plug from the power socket.

- Only use original JURA maintenance products. Use of products that are not explicitly recommended by JURA could damage your X4.

## Danger of electric shock

### **Water conducts electricity. Do not bring water and electricity into contact with one another:**

- Never touch the mains plug with wet hands.
- Do not immerse the X4 and/or mains cable in water.
- Do not put the X4 or any individual parts in the dishwasher.
- Before cleaning, switch the X4 off with the On/Off button . Always wipe the X4 with a damp cloth rather than a wet one, and protect it from prolonged exposure to water splash. The X4 must not be cleaned with a jet of water.
- The X4 is not suitable for installation on a surface where a jet of water can be used.

## Danger of burns, scalding and injury

- Do not touch the spouts during operation. Use the handles provided.
- Optionally, your X4 can be remotely operated using mobile devices. When preparing a product or initiating a maintenance programme, make sure that other people are not put at risk – for example, through contact with the spouts.

## 3 Preparing and using for the first time

### Setting up the machine



- ▶ Choose a spot for your X4 which protects the machine against overheating. Ensure that the ventilation slots are not covered.
- ▶ Place the X4 on a horizontal surface that is not sensitive to water (minimum height of 80 cm).

### Filling the bean container

The aroma preservation cover of the bean container is lockable (spanner supplied as standard).

#### CAUTION

Coffee beans which have been treated with additives (e.g. sugar), ground coffee or freeze-dried coffee will damage the grinder.

- ▶ Only use roasted, untreated coffee beans to fill the bean container.

- ▶ Remove the aroma preservation cover.
- ▶ Fill the bean container with coffee beans and close the aroma preservation cover.

### Determining the water hardness

When you use the machine for the first time, you must set the water hardness. If you know the hardness of your water, go straight to the next section. If you do not know the water hardness, you can find this out first:

- ▶ Hold the Aquadur® test strip supplied under running water for one second. Shake off the water.
- ▶ Wait for about 1 minute.
- ▶ You will then be able to read the degree of water hardness from the discolouration of the Aquadur® test strip and the description on the packaging.

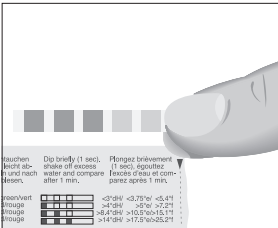

## First-time use

**⚠ WARNING**

If the machine is operated with a defective mains cable, there is a danger of potentially fatal electric shock.

- ▶ Never use a machine which is damaged or has a defective mains cable.

**CAUTION**

Milk, sparkling mineral water or other liquids can damage the water tank or the machine.

- ▶ Only fill the water tank with fresh, cold water.

**Precondition:** The bean container has been filled.

- ▶ Insert the mains plug into a power socket.
- ▶ Press the On/Off button  to switch the X4 on.  
‘Sprachauswahl’
- ▶ Press the > or < button until the desired language is displayed, e.g. ‘English’.
- ▶ Press the ‘Save’ button.  
‘Water hardness’

**i** Please refer to the section above for a description of how to determine the water hardness.

- ▶ Press the > or < button to change the setting for the water hardness.
- ▶ Press the ‘Save’ button.  
‘Filter operation’ / ‘Insert filter’
- ▶ Remove the water tank and rinse it with cold water.
- ▶ Open the filter holder.
- ▶ Insert the CLARIS Pro Smart+ / Pro Smart maxi filter cartridge into the water tank, exerting slight pressure.
- ▶ Close the filter holder. It will click into place audibly.
- ▶ Fill the water tank with fresh, cold water and reinsert the tank.

**i** The machine automatically detects that you have just inserted the filter cartridge.

‘Filter is being rinsed’, water flows directly into the drip tray.

‘System is filling’

‘Machine is heating’

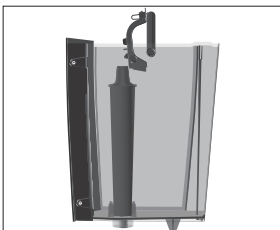

‘Machine is rinsing’

The start screen is displayed. Your X4 is ready for use.







## Managing your X4 – the JURA Cockpit

The **JURA Cockpit** allows you to manage your X4. Press the > button for **two seconds** to open the JURA Cockpit.

Symbol	Meaning
	'Maintenance' area (blue)
	'Machine settings' area (green)
	Filter mode

## 4 Preparation



### Specialities:

Page  	
'Espresso'	'Coffee'
'Americano'	'Hot water'
Page  	
'Special coffee'	'Hot water for green tea'
'Lungo'	'Jug of coffee'

### Basic information about preparing drinks:

Aim	What to do
Change the coffee strength of a single product	Press the < or > button during grinding
Change the amount for a single product	Press the < or > button during preparation

**i** The longer you press the < and > buttons, the faster your setting changes.

Aim	What to do
Permanently save the amount for a single product	Press 'Save' straight after preparation
Change the amount, coffee strength and temperature for any given product	Press the button for a product for two seconds and configure the desired settings in 'Product settings'
Display more products	Press the > button to display the second product page  
Prepare two speciality coffees (all speciality coffees except for espresso doppio)	Press the preparation button twice within two seconds
Stop preparation	Press the 'X' button

Coffee tastes best served hot. A cold porcelain cup cools the beverage – and impairs the taste. We therefore recommend prewarming the cups. You can purchase a JURA cup warmer from your specialised dealer.

## Espresso and coffee

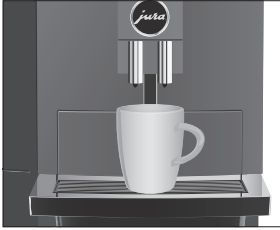

### Example: Coffee

- ▶ Place a cup under the coffee spout.
  - ▶ Press 'Coffee' (on page ●○).
- The preset amount of water for coffee flows into the cup.

## Americano and lungo

For the americano and lungo, the X4 blends the coffee with hot water using a special preparation method. This results in a full-bodied speciality coffee which is particularly easy to digest. You can change the amount of this additional water (see chapter 4 'Preparation – Adjusting the product settings').

## Espresso doppio

'Doppio' is Italian for 'double'. When you select Espresso doppio, two espressos are prepared one after the other. The result is an extra full-bodied and aromatic speciality coffee.

## Hot water

The X4 allows you to prepare different variants of hot water:

- 'Hot water'
- 'Hot water for green tea'

### ⚠ CAUTION

There is a danger of scalding from hot water splashes.

- ▶ Avoid direct contact with the skin.

### Example: Hot water for green tea

**Precondition:** The start screen is displayed.

- ▶ Place a cup under the hot-water spout.
- ▶ Press 'Hot water for green tea' (on page ○● of the start screen).

The preset amount of water flows into the cup.



## Adjusting the grinder

You can adjust the grinder to suit the degree of roast of your coffee.

The consistency of grind is correct if the coffee flows regularly from the coffee spout. In addition a fine, thick crema forms.

You can set the consistency of grind using the spanner provided.

- ▶ Open the cover behind the bean container.
- ▶ Turn the grinder adjustment switch to the desired position.
- ▶ Close the cover.

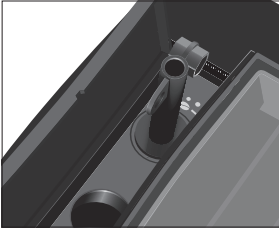

## Adjusting the product settings

Press a product button for **about two seconds** to view the list of settings:

- **'Product settings'**: Specify individual settings such as coffee strength, amount of water, etc.
- **'Reposition the product'**: Replace the products on the start screen with your favourites.

Permanent settings in programming mode always follow the same model.

**Example:** Proceed as follows to change the coffee strength for one coffee.

- ▶ Press the **'Coffee'** button for **about two seconds**.
- ▶ Press the **'Product settings'** button.  
**'Coffee strength'**

**i** Different settings will be available depending on the selected product: Press the ◀ or ▶ button to navigate the various settings.

- ▶ Press the > or < button to change the setting.
- ▶ Press the **'Save'** button.
- ▶ Press the **'X'** button to return to the start screen.

## 5 Daily operation

### Switching the machine on and off



- ▶ Place a receptacle under the coffee spout.
- ▶ Press the On/Off button .

‘Machine is rinsing’

Your X4 is switched on or off.

- ▶ **i** When the machine is switched off, the system is only rinsed if a speciality coffee has been prepared.

### Filling the water tank

Daily maintenance of the machine and hygiene when handling milk, coffee and water are key to a perfect coffee result in the cup every time. You should therefore change the water **daily**.

#### CAUTION

Milk, sparkling mineral water or other liquids can damage the water tank or the machine.

- ▶ Only fill the water tank with fresh, cold water.

You can lock the water tank cover with the spanner provided.

- ▶ Open the water tank cover.
- ▶ Remove the water tank and rinse it with cold water.
- ▶ Fill the water tank with fresh, cold water and reinsert the tank.
- ▶ Close the water tank cover.

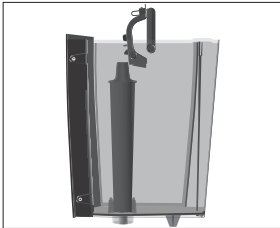

**Maintenance actions**

Optimal coffee quality depends on many factors. One important prerequisite is regular maintenance of your X4. Carry out the following steps:

Maintenance action	Daily	If necessary	Note
Empty the drip tray and coffee grounds container and rinse with warm water (The insert for the drip tray, including the drip tray itself, and the coffee grounds container are dishwasher-safe)	▪		Always empty the coffee grounds container when the machine is switched on. This is the only way of resetting the coffee grounds counter.
Rinse the water tank	▪		
Wipe the surface of the machine with a clean, soft, damp cloth (e.g. microfibre cloth)	▪		
Clean the inside of the water tank with a brush		▪	
Clean the top and bottom of the cup grille		▪	
Thoroughly clean the drip tray and coffee grounds container		▪	

**i** You will find more information about the maintenance of your X4 in the 'Maintenance'  area in the programme item 'Information'.

## 6 Machine settings

Press the > button for **two seconds** to open the JURA Cockpit. The following settings can be saved in 'Machine Settings' :

Programme item	Explanation
Page ●○○	
'Switch off after'	Set the automatic switch-off time to save energy (switch-off after 15 minutes, 30 minutes or 1 – 9 hours after the last action on the machine)
'Water hardness'	Set the hardness of the water used (1 °dH to 30 °dH) to prevent limescale building up in your machine
'Product name'	Display product images with/without product names on the start screen
'Units'	Set the unit for the amount of water (ml or oz)
Page ○●○	
'Choose language'	Set language
'Factory setting'	Reset your X4 to factory settings (the machine then switches off)
'Empty system'	Empty the system to protect the X4 from frost damage during transport (see chapter 10 'Transport and environmentally friendly disposal – Transport / Emptying the system')
'Version'	View software version
Page ○○●	
'Lock/enable'	Blocking and releasing individual products
'Product settings'	Define whether the permanent product settings can be changed or not
'One-off settings'	Permit/do not permit one-off settings during preparation
'Accessories'	Sub-menu(s) when using
(only displayed if <b>JURA Connector</b> is being used)	JURA <b>Payment Connect</b> : 'QR code' / 'Reset Payment Connect' JURA <b>Business Connect</b> : 'Pocket Pilot' / 'Reset Business Connect' JURA <b>MDB Connect</b> : 'Incasso' JURA <b>Wi-Fi Connect (V2)</b> : 'Wi-Fi connection'

## 7 Maintenance

### Basic information about maintenance:

- Press the > button for **two seconds** to open the JURA Cockpit. You can manage the maintenance of your X4 in the ☸ section.
- In the Cockpit of your X4, maintenance programmes that need to be carried out are shown in the form of messages with red backgrounds. Press the button that corresponds to the message to go straight to the maintenance programme. Maintenance programmes that are due imminently are indicated on your X4 by means of a bar display within the message.
- Carry out each maintenance programme when you are prompted to do so.

### Rinsing the machine



You can start coffee system rinsing manually at any time.

**Precondition:** The start screen is displayed.

- Place a receptacle under the coffee spout.
- Press the > button for **two seconds** to open the JURA Cockpit.
- Press the ☸ button.
- Press 'Rinse the coffee system' to start the rinse operation. 'Machine is rinsing'  
The operation stops automatically.

### Inserting/changing the filter

Once the filter cartridge stops working (depending on the water hardness setting), the X4 will prompt you to change the filter.

- ❗ Your X4 no longer has to be descaled if you are using the CLARIS Pro Smart+ / Pro Smart maxi filter cartridge.
- ❗ CLARIS Pro Smart+ / Pro Smart maxi filter cartridges are available from specialised dealers.

**Precondition:** 'Filter' is displayed in the Cockpit if the filter's capacity has been exhausted.

- Remove and empty the water tank.
- Open the filter holder and remove the **old** CLARIS Pro Smart+ / Pro Smart maxi filter cartridge.

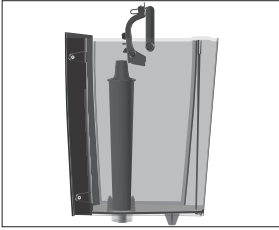

- ▶ Insert a **new** CLARIS Pro Smart+ / Pro Smart maxi filter cartridge into the water tank, exerting slight pressure.
- ▶ Close the filter holder. It will click into place audibly.
- ▶ Fill the water tank with fresh, cold water and reinsert the tank. The machine automatically detects that you have just inserted/changed the filter cartridge.  
‘Filter is being rinsed’, water flows directly into the drip tray.

## Cleaning the machine

After 180 preparations or 80 switch-on rinses, the X4 will prompt you to clean it.

### CAUTION

If the wrong cleaning agent is used, the machine could be damaged and/or traces could be left behind in the water.

- ▶ Use only original JURA maintenance products.

- ❗ The cleaning programme lasts approximately 20 minutes.
- ❗ Do not interrupt the cleaning programme. The quality of cleaning will be impaired if you do so.
- ❗ JURA cleaning tablets are available from specialised dealers.

**Precondition:** ‘Clean’ is displayed in the Cockpit.

- ▶ Press the > button for **two seconds** to open the JURA Cockpit.
- ▶ Press ‘Clean’.
- ▶ Press the ‘Start’ button.  
‘Empty grounds’
- ▶ Empty the drip tray and coffee grounds container and put them back into the machine.  
‘Clean’
- ▶ Place a receptacle under the coffee spout.
- ▶ Press the ‘Next’ button.  
Water flows out of the coffee spout.  
The operation is interrupted, ‘Add cleaning tablet’.
- ▶ Open the cover behind the bean container.

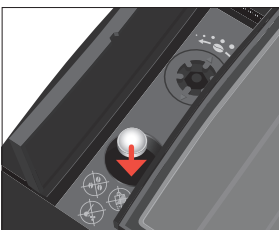

- ▶ Insert a JURA cleaning tablet into the filler funnel.
- ▶ Close the cover.
- ▶ Press the ‘Next’ button.  
Water flows out of the coffee spout several times.  
‘Empty grounds’
- ▶ Empty the drip tray and coffee grounds container and put them back into the machine.

## Descaling the machine

The X4 builds up deposits of limescale over time and automatically prompts you to descale it when necessary. The degree of calcification depends on the hardness of your water.

- ❗ If you are using a CLARIS Pro Smart+ / Pro Smart maxi filter cartridge, you will not be prompted to descale.

**⚠ CAUTION** If the descaling agent comes into contact with the skin or eyes, this can cause irritation.

- ▶ Avoid contact with the skin or eyes.
- ▶ Rinse off the descaling agent with clean water. Should you get any descaling agent in your eye, see a doctor.

**CAUTION** If the wrong descaling agent is used, the machine could be damaged and/or traces could be left behind in the water.

- ▶ Use only original JURA maintenance products.

**CAUTION** If the descaling operation is interrupted, there may be damage to the machine.

- ▶ Allow the descaling programme to run to the end.

**CAUTION** If the descaling agent comes into contact with sensitive surfaces (e.g. marble), damage cannot be ruled out.

- ▶ Clean up any splashes immediately.

- ❗ The descaling programme lasts approximately 25 minutes.

- ❗ JURA descaling tablets are available from specialised dealers.

**Precondition:** 'Descale' is displayed in the Cockpit.

- ▶ Press the > button for **two seconds** to open the JURA Cockpit.
- ▶ Press 'Descale'.
- ▶ Press the 'Start' button.  
'Empty drip tray'
- ▶ Empty the drip tray and coffee grounds container and put them back into the machine.  
'Agent in tank'
- ▶ Remove and empty the water tank.
- ▶ Completely dissolve 3 JURA descaling tablets in a receptacle holding 600 ml of water. This may take several minutes.
- ▶ Pour the solution into the **empty** water tank and insert it into the machine.

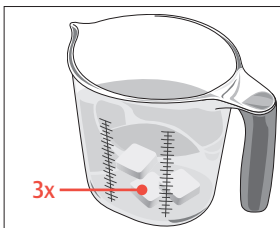



- ▶ Place a receptacle under the coffee spout.
- ▶ Press the **'Next'** button.  
Water flows repeatedly out of the hot-water nozzle.  
**'Empty drip tray'**.
- ▶ Empty the drip tray and coffee grounds container and put them back into the machine.  
**'Rinse the water tank'** / **'Fill water tank'**



- ▶ Empty the receptacle and place it under the coffee spout again.
  - ▶ Remove the water tank and rinse it thoroughly.
  - ▶ Fill the water tank with fresh, cold water and reinsert the tank.
  - ▶ Press the **'Next'** button.  
Water flows repeatedly out of the hot-water nozzle and the fine foam frother.  
**'Empty drip tray'**
  - ▶ Empty the drip tray and coffee grounds container and put them back into the machine.
- i** If the descaling operation stops unexpectedly, rinse the water tank thoroughly.

## Descaling the water tank

Limescale deposits may form in the water tank. To ensure correct function of the machine, descale the water tank from time to time.

- ▶ Remove the water tank.
- ▶ If you use a CLARIS Pro Smart+ / Pro Smart maxi filter cartridge, remove this.
- ▶ Completely fill the water tank and dissolve 3 JURA descaling tablets in it.
- ▶ Leave the water tank with the descaling solution for several hours (e.g. overnight).
- ▶ Empty the water tank and rinse it thoroughly.
- ▶ If you use a CLARIS Pro Smart+ / Pro Smart maxi filter cartridge, insert this again.
- ▶ Fill the water tank with fresh, cold water and reinsert the tank.

## Cleaning the bean container

Coffee beans may be covered with a slight oil film which remains on the walls of the bean container. These traces may negatively affect the coffee result. For this reason clean the bean container from time to time.

**Precondition:** **'Fill bean container'** is displayed.

- ▶ Switch the machine off with the On/Off button .
- ▶ Remove the aroma preservation cover.

- ▶ Clean the bean container with a soft, dry cloth.
- ▶ Fill the bean container with coffee beans and close the aroma preservation cover.

## 8 Display messages

### Messages on the start screen

Message	Cause/Result	Action
'Fill water tank'	The water tank is empty.You cannot prepare any products.	▶ Fill the water tank(see chapter 5 'Daily operation – Filling the water tank').
'Empty grounds' / 'Empty drip tray'	The coffee grounds container is full. / The drip tray is full.You cannot prepare any products.	▶ Empty the coffee grounds container and the drip tray(see chapter 5 'Daily operation – Maintenance actions').
'Drip tray not fitted'	The drip tray is not inserted correctly or is not inserted at all.You cannot prepare any products.	▶ Fit the drip tray.
'Fill bean container'	The bean container is empty.You cannot prepare any products.	▶ Fill the bean container(see chapter 3 'Preparing and using for the first time – Filling the bean container').
'Too hot'	The system is too hot to start a maintenance programme.	▶ Wait for several minutes until the system has cooled or prepare a speciality coffee or hot water.

### Messages in the Cockpit

Message	Cause/Result	Action
The filter symbol  lights up red. 'Filter'	The filter cartridge no longer works.	▶ Replace the CLARIS Pro Smart+ / Pro Smart maxi filter cartridge (see chapter 7 'Maintenance – Inserting/changing the filter').
'Clean'	The X4 is prompting you to clean it.	▶ Perform cleaning (see chapter 7 'Maintenance – Cleaning the machine').
'Descale'	The X4 is prompting you to descale it.	▶ Perform descaling (see chapter 7 'Maintenance – Descaling the machine ').

## 9 Troubleshooting

Problem	Cause/Result	Action
Coffee only comes out in drips when it is being prepared.	The coffee is ground too finely and obstructs the system.	▶ Set the grinder to a coarser setting (see chapter 4 'Preparation – Adjusting the grinder').
	The water hardness may not have been correctly set.	▶ Perform descaling (see chapter 7 'Maintenance – Descaling the machine').
There is dry ground coffee behind the coffee grounds container.	The beans used are resulting in an above-average volume of ground coffee.	▶ Reduce the coffee strength or choose a finer grinder setting (see chapter 4 'Preparation – Adjusting the product settings').
Grinder is making a very loud noise.	There are foreign objects in the grinder.	▶ Contact customer support in your country (see chapter 13 'JURA contact details / Legal information').
'ERROR 2' or 'ERROR 5' is displayed.	If the machine has been exposed to the cold for a long period of time, heating may be disabled for safety reasons.	▶ Warm the machine at room temperature.
Other 'ERROR' messages are displayed.	–	▶ Contact customer support in your country (see chapter 13 'JURA contact details / Legal information').

**i** If you were unable to solve the problem, contact customer support in your country (see chapter 13 'JURA contact details / Legal information').

## 10 Transport and environmentally friendly disposal

### Transport / Emptying the system

Keep the packaging for your X4. It should be used to protect the machine during transport.

In order to protect the X4 from frost during transport, the system must be emptied.



**Precondition:** The start screen is displayed.

- ▶ Place a receptacle under the coffee spout.
- ▶ Press the > button for **two seconds** to open the JURA Cockpit.
- ▶ Press the ⚙ button.
- ▶ Press the > button to display the programme item 'Empty system' (page ○ ● ○).
- ▶ Press 'Empty system'.

Press 'Remove the water tank'.

- ▶ Remove and empty the water tank.

'System is emptying'

Steam will continue to be discharged from the hot-water nozzle until the system is empty. Your X4 is switched off.

### Disposal

Please dispose of old machines in an environmentally neutral way.



Old machines contain valuable, recyclable materials which should be recycled. Please therefore dispose of old machines via suitable collection systems.

## 11 Technical data

Voltage	220–240 V ~, 50 Hz
Power	1450 W
Ambient conditions	Humidity max. 80 % Ambient temperature 10–35 °C
Sound pressure level	LP < 70 dB (A)
Conformity mark	<b>CE UK</b>
Pump pressure	static, max. 15 bar
Holding capacity of water tank (without filter)	5 l
Holding capacity of bean container	500 g
Holding capacity of coffee grounds container	max. 40 portions
Cable length	approx. 1.2 m
Weight	approx. 12.7 kg
Dimensions (W × H × D)	37.3 × 47 × 46.1 cm
CLARIS Pro Smart+ / Pro Smart maxi filter cartridge (RFID technology)	Frequency band 13.56 MHz Max. transmission power < 1 mW
JURA Connector (Wi-Fi connection / Bluetooth connection)	Frequency band 2.4 GHz Max. transmission power < 100 mW

Information for testers (repeat test in accordance with DIN VDE 0701-0702): The central grounding point (CGP) is located on the back of the machine, right next to the mains cable's connection point.

## 12 Index

### A

- Addresses 28
- Adjusting the product settings 14
- Americano 13
- Aroma preservation cover
  - Bean container with aroma preservation cover 5

### B

- Bean container
  - Bean container with aroma preservation cover 5
  - Cleaning 21
  - Filling 10
- Bus bar
  - Technical data 25
- Button
  - On/Off button 5

### C

- Central grounding point 25
- Children 7
- CLARIS Pro Smart filter cartridge
  - Changing 18
  - Inserting 18
- Cleaning
  - Bean container 21
  - Machine 19
- Cockpit 12, 17, 18
- Coffee 13
- Coffee grounds container 5
- Coffee spout
  - Height-adjustable coffee spout 5
- Consistency of grind
  - Adjusting the grinder 14
  - Grinder adjustment wheel 5
- Contact details 28
- Cover 5
  - Water tank 5
- Cup grille 5
- Customer support 28

### D

- Damage
  - Preventing damage 8
  - What to do in the event of damage 7

Declaration of Conformity 28

Descaling

- Machine 20
- Water tank 21

Display 5

Cockpit 12

Display messages 22

Disposal 24

Drip tray 5

- Insert 5

### E

Emptying the system 24

Errors

Troubleshooting 23

Espresso 13

Espresso doppio 13

EU Declaration of Conformity 28

### F

Filler funnel

Filler funnel for cleaning tablet 5

Filling

- Bean container 10
- Water tank 15

Filter

- Changing 18
- Inserting 18

First-time use 11

### G

Green tea 13

Grinder adjustment wheel 5

Grounding point 25

### H

Height-adjustable coffee spout 5

Hotline 28

Hot water 13

### I

Insert for drip tray 5

### J

JURA

Contact details 28

**L**

Lungo 13

**M**

Machine

Cleaning 19

Descaling 20

Rinsing 18

Setting up 10

Machine settings 17

Mains cable 5

Maintenance 18

Maintenance actions 16

Messages, display 22

**P**

Preparation 12

Americano 13

Coffee 13

Espresso 13

Espresso doppio 13

Green tea 13

Hot water 13

Lungo 13

Problems

Troubleshooting 23

Product settings

Adjusting 14

Proper use 6

**R**

RFID 25

Rinsing

Machine 18

**S**

Safety information 6

Setting up

Setting up the machine 10

Switching off 15

Switching on 15

Symbol description 6

**T**

Technical data 25

Tel 28

Transport 24

Troubleshooting 23

**U**

Use, first time 11

Users 6

**W**

Water hardness

Determining the water hardness 10

Water tank 5

Descaling 21

Filling 15

Wi-Fi 25

Wireless connection 11, 18, 25

## 13 JURA contact details / Legal information

### Your JURA service partner



JURA Elektroapparate AG  
Kaffeeweltstrasse 10  
CH-4626 Niederbuchsiten  
Tel. +41 (0)62 38 98 233

- i** You can find additional contact details for your country at **[jura.com](http://jura.com)**.
- i** If you need assistance with using your machine, you can find this at **[jura.com/service](http://jura.com/service)**.
- i** Your opinion is important to us! Use the contact details at **[jura.com](http://jura.com)**.

**Directives** The machine complies with the following directives:

- 2006/42/EC – Machinery Directive
- 2014/30/EU – Electromagnetic Compatibility
- 2009/125/EC – Ecodesign Directive
- 2011/65/EU – RoHS Directive
- 2014/53/EU – Wireless Voltage Directive

A detailed EU Declaration of Conformity for your X4 can be found at **[jura.com/conformity](http://jura.com/conformity)**.

**Technical changes** We reserve the right to make technical changes. The diagrams used in these instructions for use are for illustration purposes only and do not represent the original colours of the machine. Some details of your X4 may vary.